

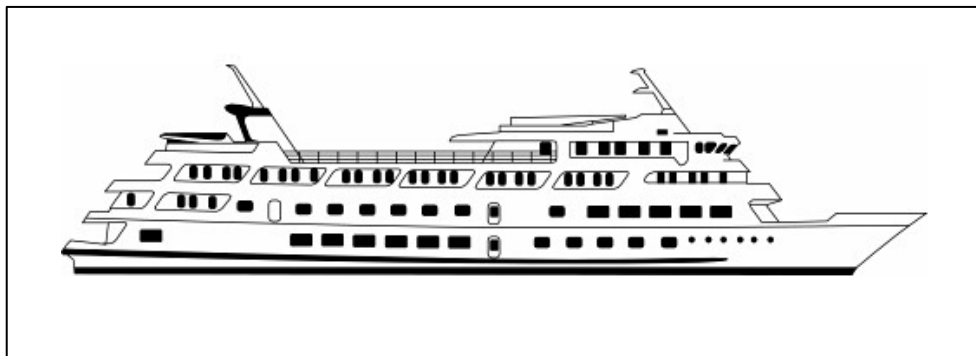

U.S. Army Corps  
of Engineers

# MIAMI OCEAN DREDGED MATERIAL DISPOSAL SITE

## SITE MANAGEMENT AND MONITORING PLAN

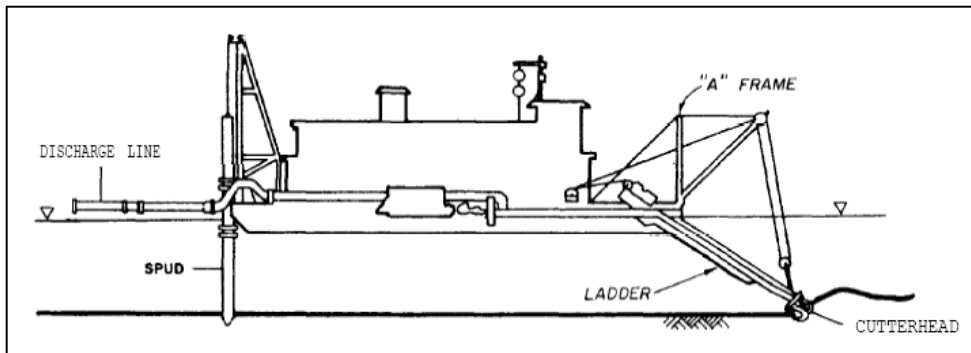
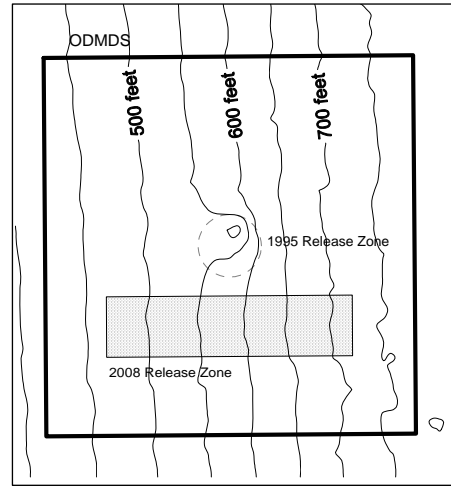
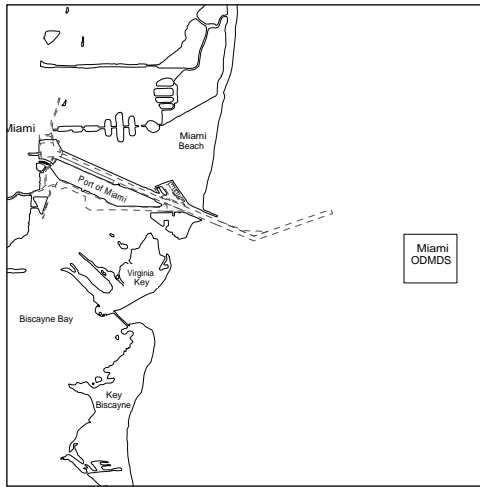

This page intentionally left  
blank for duplex printing.

The following Site Management and Monitoring Plan for the Miami ODMDS has been developed and agreed to pursuant to the Water Resources Development Act Amendments of 1992 (WRDA 92) to the Marine Protection, Research, and Sanctuaries Act of 1972 for the management and monitoring of ocean disposal activities, as resources allow, by the U.S. Environmental Protection Agency and the U.S. Army Corps of Engineers.



Colonel Paul L. Grosskruger  
District Commander  
Jacksonville District  
U.S. Army Corps of Engineers  
Jacksonville, Florida

12/17/08

Date

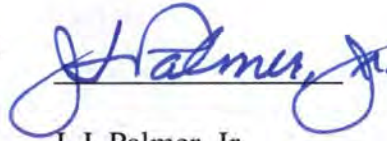

J. I. Palmer, Jr.  
Regional Administrator  
U.S. Environmental Protection Agency  
Region 4  
Atlanta, Georgia

9/19/09

Date

This plan is effective from the date of signature for a period not to exceed 10 years. The plan shall be reviewed and revised more frequently if site use and conditions at site indicate a need for revision.

This page intentionally left  
blank for duplex printing.

**MIAMI OCEAN DREDGED MATERIAL DISPOSAL SITE (ODMDS)  
SITE MANAGEMENT AND MONITORING PLAN**

**TABLE OF CONTENTS**

<u>Section</u>	<u>Page</u>
1.0 INTRODUCTION .....	1
1.1 Site Management and Monitoring Plan Team .....	1
2.0 SITE MANAGMENT.....	2
2.1 Disposal Site Characteristics.....	2
2.2 Management Objectives.....	2
2.3 Disposal History and Dredged Material Volumes .....	5
2.4 Dredged Material Characteristics .....	6
2.5 Time of Disposal.....	7
2.6 Disposal Technique.....	7
2.7 Disposal Route .....	7
2.8 Disposal Location .....	7
2.9 Permit and Contract Conditions.....	8
2.10 Permit Process.....	9
2.11 Information Management of Dredged Material Placement Activities.....	9
3.0 SITE MONITORING .....	9
3.1 Baseline Monitoring.....	10
3.2 Disposal Monitoring .....	14
3.3 Post Discharge Monitoring .....	14
3.4 Summary of Results of Past Monitoring Surveys.....	14
3.5 Future Monitoring Surveys .....	18
3.6 Reporting and Data Formatting .....	18
3.6.1 Project Initiation and Violation Reporting.....	18
3.6.2 Disposal Monitoring Data.....	18
3.6.3 Post Disposal Summary Reports.....	21
3.6.4 Environmental Monitoring.....	21
4.0 MODIFICATION OF THE MIAMI ODMDS SMMP.....	21
5.0 REFERENCES .....	22

LIST OF FIGURES

<u>Figure No.</u>	<u>Title</u>	<u>Page</u>
Figure 1.	Miami ODMDS Location Map.....	3
Figure 2.	Miami ODMDS 2007 Bathymetry.....	4
Figure 3.	Miami ODMDS Disposal Release Zones .....	8
Figure 4.	Distribution of Dredged Material Based on Analysis of Sediment Profile Images at the Miami ODMDS .....	16
Figure 5.	Bathymetric Trends at the Miami ODMDS.....	17

LIST OF TABLES

<u>Table No.</u>	<u>Title</u>	<u>Page</u>
Table 1.	Volume of Dredged Material Placed in the Miami ODMDS .....	5
Table 2.	Disposal Release Zone.....	7
Table 3.	Summary of Permit and Contract Conditions.....	9
Table 4.	Surveys Conducted at the Miami ODMDS .....	11-13
Table 5.	Miami ODMDS Monitoring Strategies and Thresholds for Action .....	18-19

APPENDICES

Appendix A	STFATE Water Quality Model Standard Input Parameters
Appendix B	Template: Generic Special Conditions for MPRSA Section 103 Permits
Appendix C	Template: Typical Contract Language for Implementing the Miami ODMDS SMMP Requirements

## Miami ODMDS Site Management and Monitoring Plan

### 1.0 INTRODUCTION

It is the responsibility of the U.S. Environmental Protection Agency (EPA) and the U.S. Army Corps of Engineers (USACE) under the Marine Protection, Research, and Sanctuaries Act (MPRSA) of 1972 to manage and monitor each of the Ocean Dredged Material Disposal Sites (ODMDSs) designated by the EPA pursuant to Section 102 of MPRSA. Section 102(c)(3) of the MPRSA requires development of a Site Management and Monitoring Plan (SMMP) for each ODMDS and review and revision of the SMMP not less frequently than every 10 years. The 1996 document, *Guidance Document for Development of Site Management Plans for Ocean Dredged Material Disposal Sites* (EPA/USACE, 1996) and the EPA, Region 4 and USACE South Atlantic Division Memorandum of Understanding (EPA/USACE, 2007) have been used as guidance in developing this SMMP.

A SMMP was first developed for the Miami ODMDS in August 1995. This revision to the Miami ODMDS SMMP supersedes the 1995 SMMP. Upon finalization of this revised SMMP, the SMMP provisions shall be requirements for all dredged material disposal activities at the site. All Section 103 (MPRSA) ocean disposal permits or contract specifications shall be conditioned as necessary to assure consistency with the SMMP.

1.1 Site Management and Monitoring Plan Team. An interagency SMMP team was established to assist EPA and USACE in developing the 1995 Miami ODMDS SMMP. The team consisted of the following agencies and their respective representatives:

- Jacksonville District Corps of Engineers
- State of Florida (Office of Federal Activities)
- EPA Region 4
- National Oceanic and Atmospheric Administration – Atlantic Oceanographic and Meteorological Laboratory
- Port of Miami

These agencies will continue to be consulted by EPA and the USACE in revisions to the Miami ODMDS SMMP. The team will assist EPA and USACE on deciding on appropriate disposal practices, appropriate monitoring techniques, the level of monitoring, the significance of results and potential management options.

Specific responsibilities of EPA and the Jacksonville District Corps of Engineers are:

EPA: EPA is responsible for designating/designating MPRSA Section 102 Ocean Dredged Material Disposal Sites, for evaluating environmental effects of disposal of dredged material at these sites and for reviewing and concurring on dredged material suitability determinations.

USACE: The USACE is responsible for evaluating dredged material suitability, issuing MPRSA Section 103 permits, regulating site use and developing and implementing disposal monitoring programs.

## 2.0 SITE MANAGEMENT

Section 228.3 of the Ocean Dumping Regulations (40 CFR 220-229) states: "Management of a site consists of regulating times, rates, and methods of disposal and quantities and types of materials disposed of; developing and maintaining effective ambient monitoring programs for the site; conducting disposal site evaluation studies; and recommending modifications in site use and/or designation."

### 2.1 Disposal Site Characteristics

The designation of the Miami ODMDS can be found in 40 CFR 228.15(h)(19). The Miami ODMDS is an approximately 1 nautical mile (nmi) by 1 nmi square area centered at the coordinates 25°45.00'N latitude and 80°03.37'W longitude (NAD 27) or state plane coordinates 516,078 ft N and 966,926 ft E (NAD83). The site coordinates are as follows:

	Geographic (NAD27)		Geographic (NAD83)		State Plane (FL East 0901 Ft NAD83)	
Center	25°45.00'N	80°03.37'W	25°45.02'N	80°03.35'W	516,078 N	966,926 E
NW Corner	25°45.50'N	80°03.90'W	25°45.52'N	80°03.89'W	519,086 N	963,978 E
NE Corner	25°45.50'N	80°02.83'W	25°45.52'N	80°02.82'W	519,128 N	969,829 E
SW Corner	25°44.50'N	80°03.90'W	25°44.52'N	80°03.89'W	513,028 N	964,021 E
SE Corner	25°44.50'N	80°02.83'W	25°44.52'N	80°02.82'W	513,070 N	969,874 E

The site is 4.7 nmi offshore (as measured to the center) with an area of approximately 1 nmi<sup>2</sup>. Figure 1 shows the location of the Miami ODMDS. As of 2007, it had a depth range of 415 to 770 feet (127 to 235) meters, with an average depth of 590 feet (180 meters). Figure 2 shows the most recent bathymetry of the Miami ODMDS and the area immediately to the north. The benthos consists mostly of very fine sands and coarse silt with areas of limestone rubble as a result dredged material disposal.

2.2 Management Objectives. Appropriate management of an ODMDS is aimed at assuring that disposal activities will not unreasonably degrade or endanger human health, welfare, the marine environment or economic potentialities (MPRSA §103(a)). The primary objectives in the management of the Miami ODMDS are:

- Protection of the marine environment;
- Documentation of disposal activities and compliance; and
- Maintenance of a long term disposal alternative for dredged material generated in the Miami, Florida vicinity.



The following sections provide the framework for meeting these objectives to the extent possible.

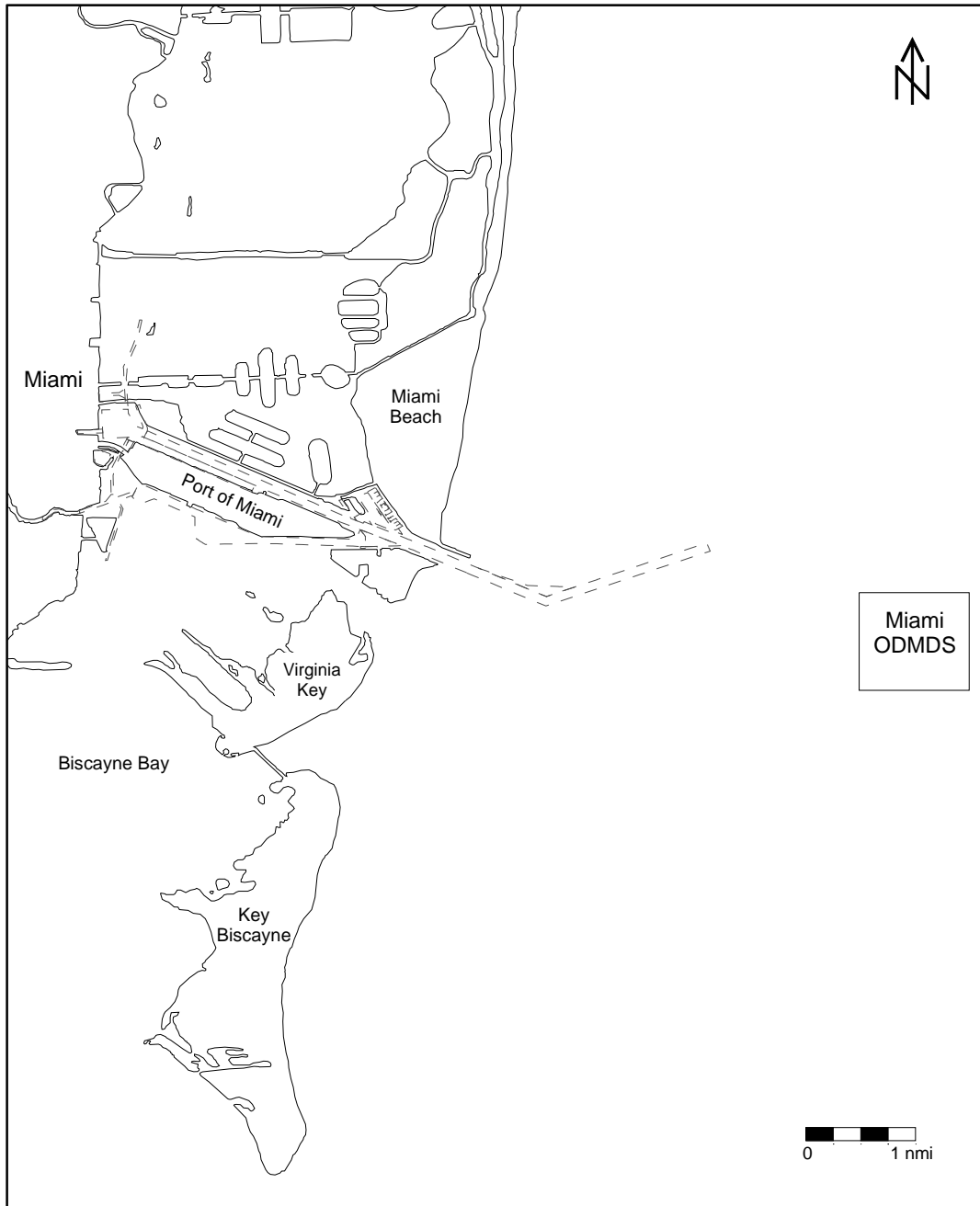

**Figure 1: Miami ODMDS Location**

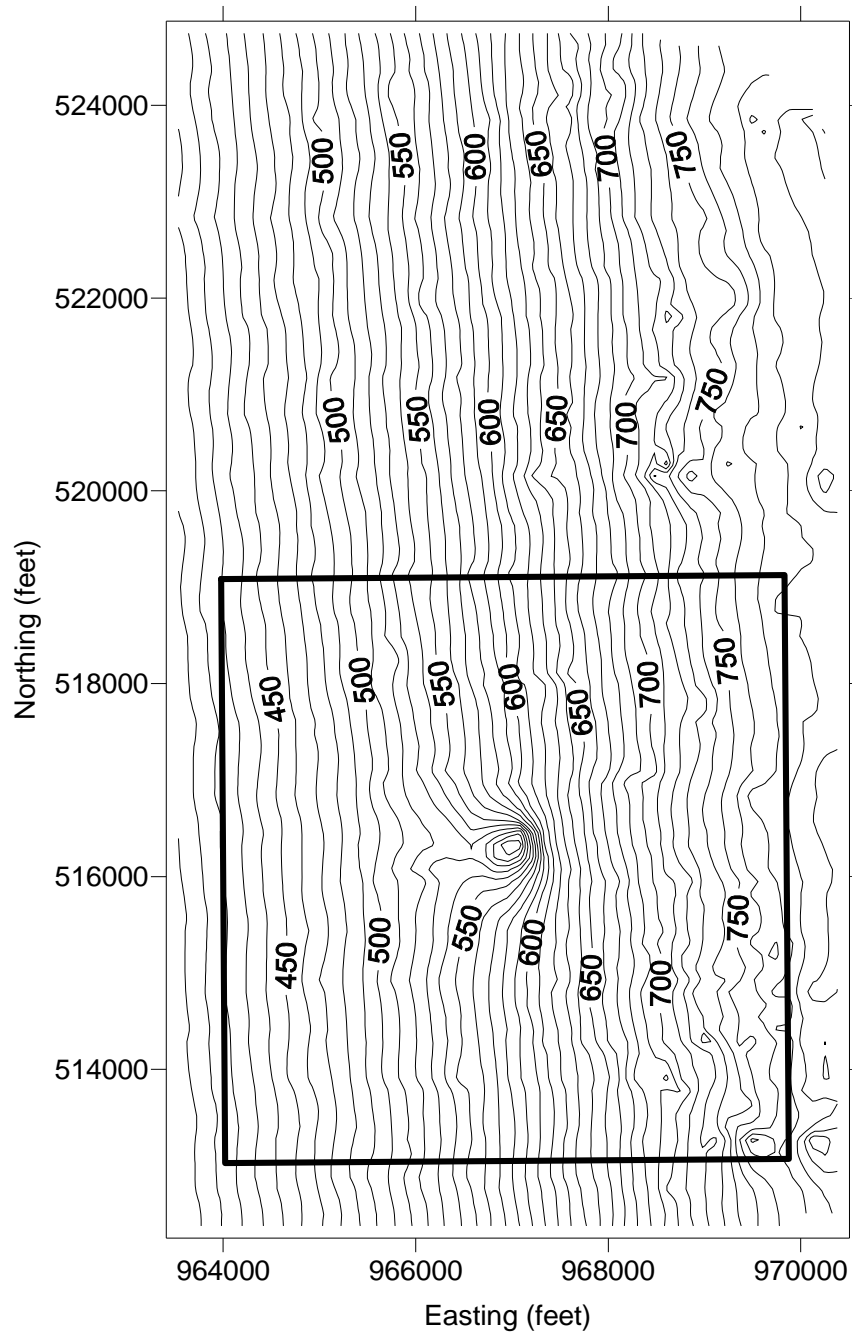

**Figure 2: Miami ODMDS 2007 Bathymetry**

**2.3 Disposal History and Dredged Material Volumes.** The Miami ODMDS and vicinity has been used for the ocean disposal of dredged material since 1957. Table 1 outlines the history of disposal of dredged material.

**Table 1.** Volume of Dredged Material Placed in the Miami ODMDS

YEAR	DREDGED MATERIAL QUANTITY - CUBIC YARDS (paid <i>in situ</i> volume)			Notes
	Maintenance	Construction	Total	
1957 <sup>1</sup>	80,000		80,000	Disposed approximately 1 nmi shoreward of current ODMDS
1960 <sup>1,2</sup>	80,083		80,083	Disposed approximately 1 nmi shoreward of current ODMDS
1964 <sup>2</sup>		2,957,443	2,957,443	
1965 <sup>2</sup>	38,935		38,935	
1966 <sup>2</sup>	54,173		54,173	
1968 <sup>1</sup>	210,000		210,000	Disposed approximately 1 nmi shoreward of current ODMDS
1985 <sup>1</sup>	15,000		15,000	Disposed approximately 1 nmi shoreward of current ODMDS
1990	225,000		225,000	Silt/clay
1993 <sup>2</sup>	247,000		247,000	Sand
1995 <sup>2</sup>	3,000		3,000	Sand/gravel from U.S. Coast Guard
1995		300	300	Limerock rubble from NOAA Reef Restoration
1995-1999		2,800,000	2,800,000	Sand/silt/rock from Phase II Deepening
2005 <sup>3</sup>		1,348,000	1,348,000	Blasted rock from completion of Phase II Deepening
2006 <sup>3</sup>	270,000		270,000	Sand/silt
<b>Total</b>	<b>1,223,191</b>	<b>7,105,743</b>	<b>8,333,934</b>	
<b>Total: Post Final Designation (1995)</b>	<b>273,000</b>	<b>4,148,300</b>	<b>4,426,300</b>	

<sup>1</sup>Data from Miami ODMDS EIS (EPA, 1995)

<sup>2</sup>Data from the Jacksonville District 1999 Fax to EPA

<sup>3</sup>Data from the Jacksonville District Post Disposal Monitoring Reports

Since final designation in 1995, the Miami ODMDS has been used mostly for disposal of construction (new work) dredged material. Disposal of maintenance material is not expected on a routine basis. A deepening project (Phase III) at the Port of Miami has been authorized. It is expected that up to 6 million cubic yards of dredged material will be generated as a result of this deepening (USACE, 2004). Approximately 3.8 million cubic yards of sand and rock is planned for disposal at the Miami ODMDS. The project is not expected to result in a significant increase in the amount of maintenance dredged material generated.

Post-disposal monitoring results (see section 3.4) have indicated that the Miami ODMDS may not be of sufficient size to contain the footprint of dredged material from the major deepening project. EPA has recommended that the capacity of the ODMDS be evaluated prior to approval of disposal of material from the Phase III project (EPA, 2004). Should management options not be sufficient to contain the footprint within the ODMDS boundaries, the site should either be permanently enlarged through an EPA site modification pursuant to Section 102 of the MPRSA or a one-time site selection by the USACE pursuant to Section 103 of the MPRSA.

2.4 Dredged Material Characteristics. The composition of dredged material dumped at the Miami ODMDS has been variable ranging from sand and silt to limestone rubble. Future dredged material disposed at the ODMDS is expected to be similar in terms of composition.

The disposition of any significant quantities of beach compatible sand from future projects will be determined during permitting activities for any such projects. It is expected that the State of Florida will exercise its authority and responsibility, regarding beach nourishment, to the full extent during any future permitting activities. Utilization of any significant quantities of beach compatible dredged material for beach nourishment is strongly encouraged and supported by EPA. Disposal of non-beach quality sand should be planned to allow the material to be placed so that it will be within or accessible to the sand-sharing system, to the maximum extent practical, and following the provisions of the Clean Water Act. Disposal of coarser material, such as rubble, should be coordinated with the local agencies, the State of Florida and EPA to promote possible beneficial uses of the material.

The suitability of dredged material for ocean disposal must be verified by the USACE and agreed to (concurred) by EPA prior to disposal. Verification will be valid for three years from the time last verified. Verification will involve: 1) a case-specific evaluation against the exclusion criteria (40 CFR 227.13(b)), 2) a determination of the necessity for testing including bioassay (toxicity and bioaccumulation) testing for non-excluded material based on the potential for contamination of the sediment since last tested, and 3) carrying out the testing (where needed) and determining that the non-excluded, tested material is suitable for ocean disposal.

Documentation of suitability will be completed prior to use of the site. Documentation will be in the form of a MPRSA Section 103 Evaluation. The Evaluation and any testing will follow the

procedures outlined in the 1991 EPA/USACE Dredged Material Testing Manual and 1993 Regional Implementation Manual (RIM) or the appropriate updated versions. This includes how dredging projects will be subdivided into project segments for sampling and analysis. The MPRSA Section 103 Evaluation will be in the form outlined in Appendix B of the RIM. Water Quality Compliance determinations will be made using the STFATE (ADDAMS) model and the input parameters provided in Appendix A. Only material determined to be suitable through the verification process by the USACE and EPA, Region 4 will be placed at the Miami ODMDS.

**2.5 Time of disposal.** No restrictions have been determined to be necessary for disposal related to seasonal variations in ocean current or biotic activity. Based on monitoring results (see section 3.4), restrictions on disposal during certain ocean currents are no longer required. As additional monitoring results are compiled, should any such restrictions appear necessary, disposal activities will be scheduled so as to avoid adverse impacts. Additionally, if new information indicates that endangered or threatened species are being adversely impacted, restrictions may be imposed.

**2.6 Disposal Technique.** No specific disposal technique is required for this site. Standard surveillance and evasive measures to protect sea turtles and marine mammals shall be employed during all disposal operations at the ODMDS.

**2.7 Disposal Route.** Disposal vessels must remain with the navigation channel while west of the buoy G"1." Disposal vessels are also not allowed to transit the Particularly Sensitive Sea Area south of the channel.

**2.8 Disposal Location.** Based on the results of monitoring surveys (see section 3.4), the disposal release zone has been modified from that specified in the 1995 SMMP. This disposal release zone is approximately 2.4 times larger and 1,285 feet south of the 1995 disposal release zone. The disposal release zone measures 985 feet by 3,895 feet. The disposal release zone coordinates are as follows:

**Table 2.** Disposal Release Zone

	Geographic (NAD83)		State Plane (FL East 0901 Ft NAD83)	
	Center	25°44.81'N	81°03.36'W	514,789 N
NW Corner	25°44.89'N	81°03.71'W	515,260 N	964,970 E
NE Corner	25°44.89'N	81°03.00'W	515,288 N	968,866 E
SW Corner	25°44.73'N	81°03.71'W	514,291 N	964,977 E
SE Corner	25°44.73'N	81°03.00'W	514,319 N	968,873 E

Disposal shall be initiated within the disposal release zone and shall be completed (doors closed) prior to departing the ODMDS.

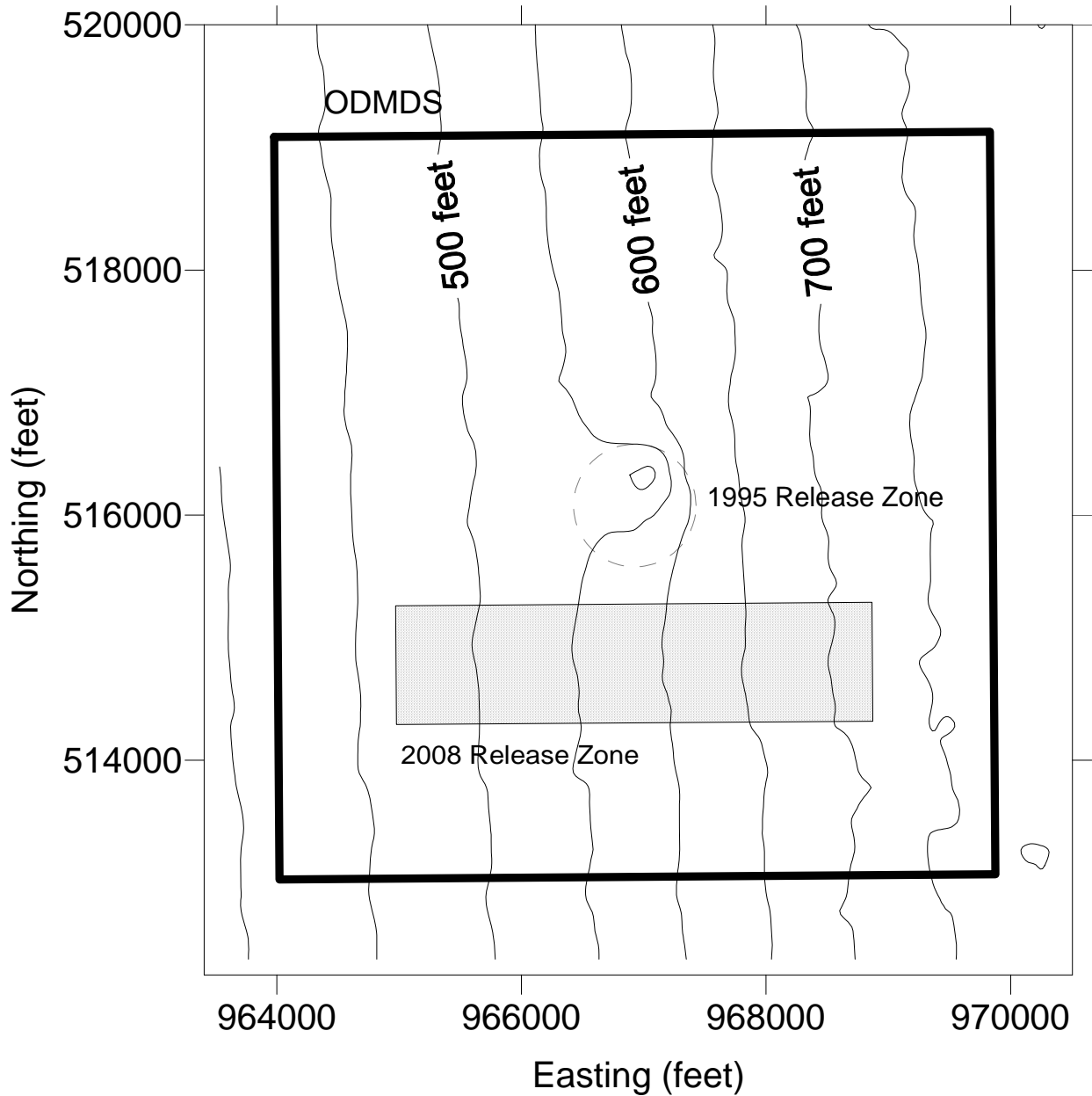

Figure 3: Miami ODMDS Disposal Release Zones (coordinates are in Florida State Plan NAD83 feet)

2.9 Permit and Contract Conditions. The disposal monitoring and post-disposal monitoring requirements described under Site Monitoring (section 3.0) will be included with the management requirements described in this section as permit conditions on all MPRSA Section 103 permits and will be incorporated in the contract language for all federal projects. A summary of the management and monitoring requirements to be included is listed in Table 3. Template language that can be used is included in appendices (see Appendix B and C).

**Table 3.** Summary of Permit and Contract Conditions

Condition	Reference
Dredged Material Suitability and Term of Verification	Miami ODMDs SMMP page 6 Regional Implementation Manual
Disposal Release Zone	Miami ODMDs SMMP page 7
Pre and Post Bathymetric Surveys	Miami ODMDs SMMP page 10 and 14
Disposal Monitoring	Miami ODMDs SMMP page 14
Reporting Requirements	Miami ODMDs SMMP page 18 and 21

2.10 Permit Process. All disposal of dredged material in the ocean, with the exception of Federal Civil Works projects, requires an ocean dumping permit issued by the USACE pursuant to Section 103 of the MPRSA. A summary of the permitting process can be found at: [http://www.epa.gov/region4/water/oceans/Dredged\\_Material\\_Permit\\_Process.htm](http://www.epa.gov/region4/water/oceans/Dredged_Material_Permit_Process.htm).

2.11 Information Management of Dredged Material Placement Activities. As discussed in the following sections, a substantial amount of diverse data regarding use of the Miami ODMDs and effects of disposal is required from many sources. If this information is readily available and in a useable format it can be used to answer many questions typically asked about a disposal site:

- What is being dredged?
- How much is being dredged?
- Where did the dredged material come from?
- Where was the dredged material placed?
- Was dredged material dredged correctly? disposed correctly?
- What will happen to the environment at the disposal site?

In an attempt to streamline data sharing, EPA Region 4 and USACE South Atlantic Division have agreed on an eXtensible Markup Language (XML) standard for sharing of disposal monitoring data (see also Section 3.6). Additional standards will continue to be investigated for sharing of other disposal site related information (e.g. environmental monitoring data, testing data, etc.).

### 3.0 SITE MONITORING

The MPRSA establishes the need for including a monitoring program as part of the Site Management Plan. Site monitoring is conducted to ensure the environmental integrity of a disposal site and the areas surrounding the site and to verify compliance with the site designation criteria, any special management conditions, and with permit requirements. Monitoring programs should be flexible, cost effective, and based on scientifically sound procedures and methods to meet site-specific monitoring needs. The intent of the program is to provide the

following:

- (1) Information indicating whether the disposal activities are occurring in compliance with the permit and site restrictions;
- (2) Information indicating the short-term and long-term fate of materials disposed of in the marine environment.
- (3) Information concerning the short-term and long-term environmental impacts of the disposal;

The main purpose of a disposal site monitoring program is to determine whether dredged material site management practices, including disposal operations, at the site need to be changed to avoid significant adverse impacts.

3.1 Baseline Monitoring. Site characterization surveys of the ODMDS have been conducted by EPA and the USACE as part of the designation process. These are summarized in Table 4.

Bathymetric surveys will be used to monitor the disposal mound to assist in verification of material placement, to monitor bathymetry changes and trends and to insure that the site capacity is not exceeded, i.e., the mound does not exceed the site boundaries. The need for pre-disposal bathymetric surveys will depend on project volumes. Pre-disposal surveys will be required within three (3) months prior to the dredging cycle or project disposal for projects greater than 100,000 cubic yards. Surveys will conform to the minimum performance standards for Corps of Engineers Hydrographic Surveys for "Other General Surveys & Studies" as described in the USACE Engineering Manual, EM1110-2-1003, *Hydrographic Surveying* dated January 1, 2002 [<http://www.usace.army.mil/publications/eng-manuals/em1110-2-1003/toc.htm>]. The number and length of transects required will be sufficient to encompass the ODMDS and a 500 foot wide area around the site. The surveys will be taken along lines spaced at 500-foot intervals or less. The minimum performance standards from table 3-1 in *Hydrographic Surveying* shall be followed. Horizontal location of the survey lines and depth sounding points will be determined by an automated positioning system utilizing a differential global positioning system. The vertical datum will be referenced to prescribed NOAA Mean Lower Low Water (MLLW) datum. The horizontal datum should be referenced to the local State Plane Coordinate System (SPCS) for that area or in Geographical Coordinates (latitude-longitude). The horizontal reference datum should be the North American Datum of 1983 (NAD 83). No additional pre-disposal monitoring at this site is required.



**Table 4.** Surveys Conducted at the Miami ODMDS

Survey Title	Conducted by	Date	Purpose	Conclusion
<i>Environmental Survey in the Vicinity of an Ocean Dredged Material Disposal Site, Miami Harbor, Florida</i>	Conservation Consultants, Inc.	1985	Physical, Chemical and Biological Characterization of the ODMDS.	Included physical and chemical analysis of the sediments; chemical analysis of the water column; characterization of the benthic macroinvertebrates, meiofauna and macroepifauna; chemical analysis of fish and invertebrate tissue samples. A video survey and bathymetry of the site was also completed.
<i>Miami Harbor Dredged Material Disposal Project</i>	NOAA-AOML	1991	Compare in-situ measurement of dredged material disposal plume suspended sediment concentrations to results of numerical modeling.	The material disposed, except for a low concentration residual remaining within the water column, reached the bottom within the designated site boundaries. A very rapid convective descent of the central core discharge plume was observed to occur.
<i>Miami Harbor Dredge Material Disposal Project: Total Suspended Solids Measurements</i>	NOAA-AOML	1993	Obtain field measurements of total suspended solids (TSS) for a number of dredged material discharges.	Initial (1 minute after disposal) surface TSS concentration ranged from 34 to 77 mg/l. Approximately 30 minutes after discharge, plume concentrations decreased to a few mg/l. The general direction of transport was north-northeast.
Pre-Disposal Bathymetry	USACE Jacksonville District	1995	Pre-disposal bathymetry	No observable disposal mound.
<i>Miami ODMDS Sidescan Sonar Survey</i>	U.S. EPA Region 4	1998	Look for evidence of dredged material on the bottom.	Numerous mounds of limestone rubble throughout and to the west and northwest of the ODMDS were observed.
<i>Real-Time Current Monitoring at the Miami ODMDS</i>	NOAA-AOML	1995-2000, 2005-2006	Monitor currents and cease disposal operations during shoreward directed current events.	Shoreward directed currents capable of transporting disposed material towards reef are infrequent (NOAA, 2006)

**Table 4 (Continued).** Surveys Conducted at the Miami ODMDS

Survey Title	Conducted by	Date	Purpose	Conclusion
Miami ODMDS Sediment Survey	U.S. EPA Region 4	June 2000	1) Characterize sediments in anomalous areas identified in the sidescan sonar record; 2) document environmental trends in the physical and chemical characteristics of the benthic sediments.	1) no significant changes in sediment chemistry; 2) stations to the north of the ODMDS remained unchanged; 3) many areas are now coarser grained or contain limestone rubble.
<i>Pre-disposal Bathymetry Survey</i>	USACE Jacksonville	June 2005	Pre-disposal bathymetry	No observable disposal mound.
<i>Plume Tracking/Measurement</i>	EPA Region 4 / NOAA-AOML	August & October 2005	Obtain suspended sediment concentrations of disposal plume.	Concentrations dropped below 10mg/l within 30 minutes from disposal at water depths of 5 and 10 meters.
<i>Coral Sediment Stress Study</i>	EPA Region 4/NOAA-AOML/GATech	2005-2006	Determine if dredged material disposal is inducing a stress response in hermatypic corals on nearby coral reefs.	
<i>Post-Disposal Sediment Profile Imaging at the Miami ODMDS</i>	U.S. EPA Region 4 / Germano & Assoc., Inc.	May 2006	1) map the spatial distribution of disposed dredged material on the seafloor; 2) characterize physical changes in the seafloor resulting from disposal; 3) evaluate benthic recolonization.	1) elliptical deposit of dredged material detected on the seafloor extending beyond the site boundaries; 2) main physical change is a shift in sediment texture to coarser sediments; 3) no adverse changes in oxygen demand, redox state detected within or around the disposal site; 4) benthos appeared in an intermediate to advanced stage of benthic recolonization.
<i>Post Disposal Bathymetry Survey</i>	USACE Jacksonville District	June and August 2007	Document bathymetric changes.	A mound approximately 25 meters high has formed in the center of the ODMDS. Bathymetry surveys at this depth are accurate to approximately +/-3 meters.

Survey Title	Conducted by	Date	Purpose	Conclusion
<i>Post Disposal Status &amp; Trends Survey of the Miami ODMDS</i>	EPA Region 4 and Barry Vittor and Associates	October 2007	Assess the extent and trends of environmental impact.  (Includes assessment of the macroinfaunal communities within and outside of the ODMDS, sediment grain size, sediment chemistry and water quality)	Results pending. There exists a significant amount of limestone rubble near the center of the ODMDS that did not exist previously.

3.2 Disposal Monitoring. For all disposal activities, an electronic tracking system (ETS) must be utilized. The ETS will provide surveillance of the transportation and disposal of dredged material. The ETS will be maintained and operated to continuously track the horizontal location and draft condition (nearest 0.5 foot) of the disposal vessel (ie. hopper dredge or disposal scow) from the point of dredging to the disposal site, and return to the point of dredging. Data shall be collected at least every 500 feet during travel to and from the ODMDS and every minute or every 200 feet of travel, whichever is smaller, while approaching within 1,000 feet and within the ODMDS. In addition to the continuous tracking data, the following trip information shall be electronically recorded for each disposal cycle:

- a. Load Number
- b. Disposal Vessel Name and Type (e.g. scow)
- c. Tow Vessel Name (if applicable)
- d. Captain of Disposal or Tow Vessel
- e. Estimated volume of Load
- f. Description of Material Disposed
- g. Source of Dredged Material
- h. Date, Time and Location at Start at Initiation and Completion of Disposal Event

It is expected that disposal monitoring will be conducted utilizing the Silent Inspector (SI) system for Civil Works projects [see <http://si.usace.army.mil>]. Disposal monitoring and ETS data will be reported to EPA Region 4 on a daily basis utilizing the eXtensible Markup Language (XML) specification and protocol per Section 3.6. EPA Region 4 and the USACE District shall be notified within 24 hours if disposal occurs outside of the ODMDS or specified disposal zone or if excessive leakage occurs.

3.3 Post Discharge Monitoring. As a follow-up to the pre-disposal bathymetric survey, the USACE or other site users will conduct a bathymetric survey within 60 days after disposal project completion for projects greater than 100,000 cubic yards. The number of transects required will be the same as in the pre-disposal survey. Bathymetric survey results will be used to insure that unacceptable mounding is not occurring and to aid in environmental effects monitoring.

3.4 Summary of Results of Past Monitoring Surveys. Surveys conducted at the Miami ODMDS are listed in Table 4. The original SMMP identified two major monitoring objectives: 1) assess the intensity and frequency of disposal plumes reaching nearshore reefs, and 2) assess the potential for long-term transport of dredged material towards critical habitats. The surveys summarized in Table 4 above have demonstrated that the likelihood of dredged material disposal plumes reaching nearshore reefs is very low and that the frequency of onshore current events are much less frequent than originally anticipated. The surveys have also shown that there is no indication of material being transported in the long-term towards critical habitats. However, the

results have shown that material is being transported in the short-term (during initial disposal) and deposited outside of the disposal site boundaries to the north (see figure 4).

Monitoring results have also shown that there are rubble mounds throughout the site and to the west and northwest of the site. Due to the historical use of the vicinity for disposal of construction dredged material, it cannot be determined when these mounds were created. Bathymetry results have shown that a significant mound (25 meters) was formed during the last phase of the Miami Harbor Deepening Project near the center of the site (see figure 5) and subsequent surveys have shown that this mound contains a significant amount of limestone rubble. Surveys have also shown that the native benthic community has been able to recolonize areas that had been disturbed by dredged material disposal.

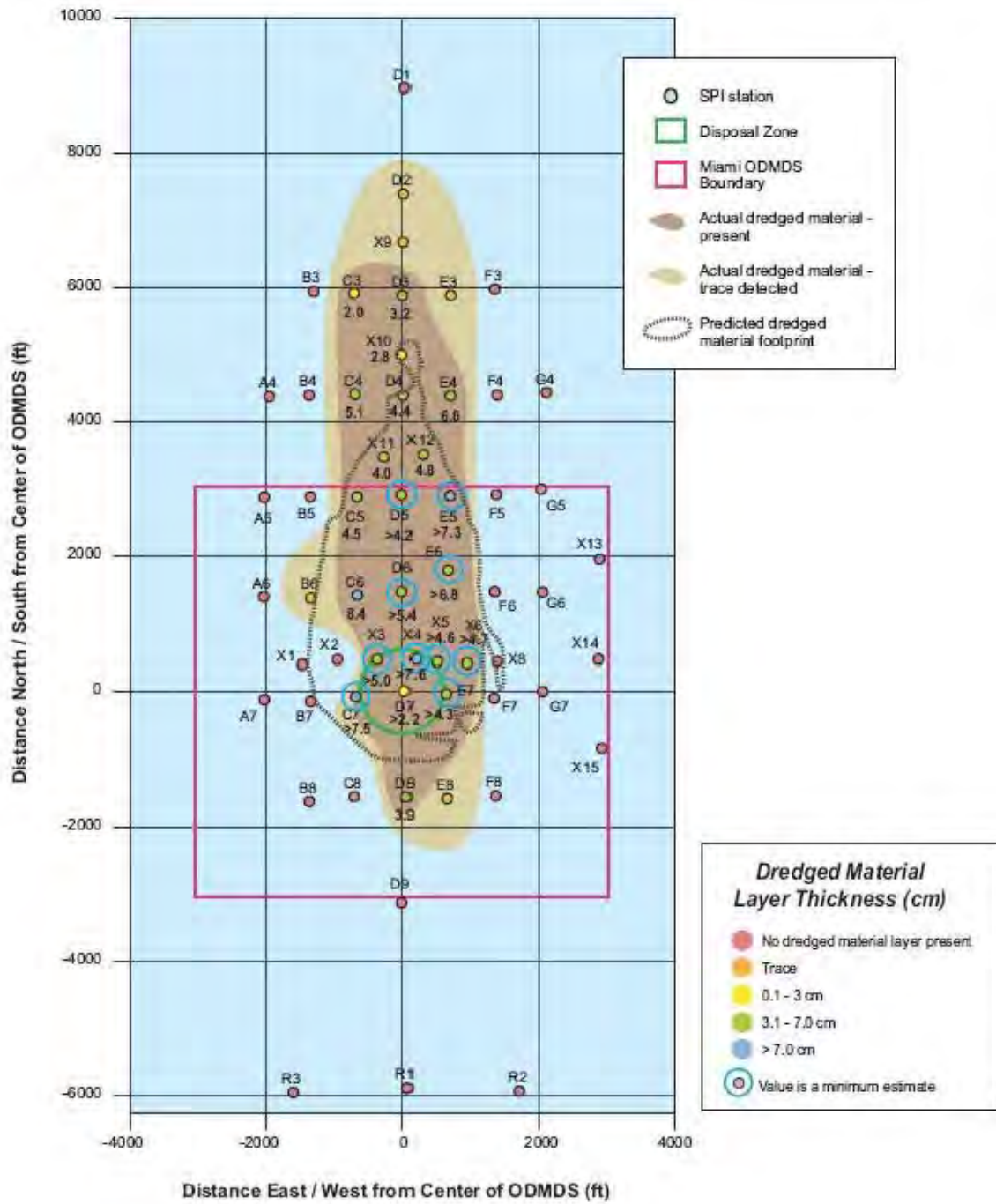
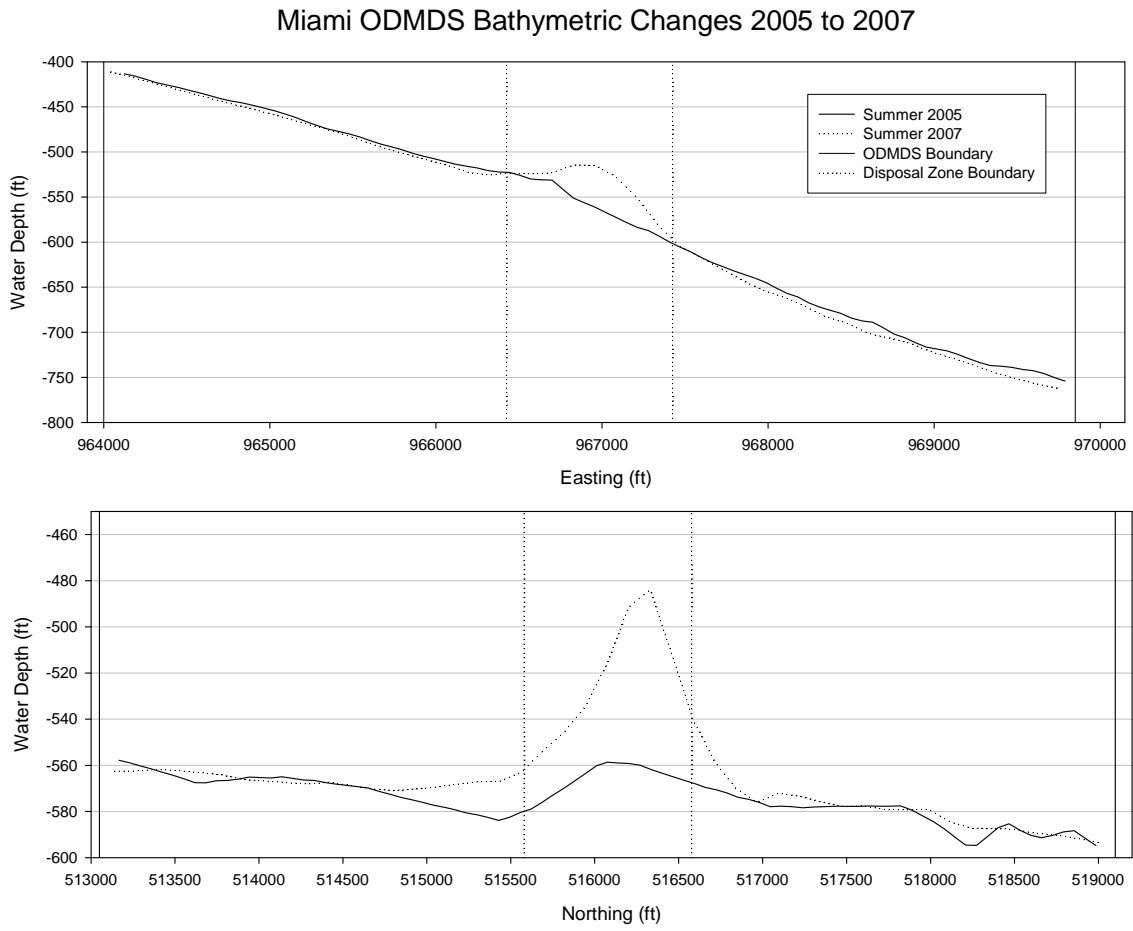

Figure 4: Distribution of dredged material based on analysis of sediment profile images at the Miami



**Figure 5. Bathymetric Trends at the Miami ODMDS**

3.5 Future Monitoring Surveys. Based on the type and volume of material disposed and impacts of concern, various monitoring surveys can be used to determine if and where the disposed material is moving, and what environmental effect the material is having on the site and adjacent areas.

Changes in bathymetry at the ODMDS will continue to be monitored in accordance with sections 3.1 and 3.3. The aerial extent of the disposal footprint should continue to be monitored using the SPI technology. At a minimum this type of survey should be conducted following the next new work project to document the effectiveness of the modified disposal zone in maintaining the disposal footprint within the ODMDS boundaries. The SPI technology can also be used to document any shoreward migration of disposed dredged material. Additionally, status and trends surveys of the benthos and water column will continue to be performed periodically (approximately every 10 years) as resources allow. A summary of the monitoring strategies for the Miami ODMDS and thresholds for management actions are presented in Table 5.

Should future disposal at the Miami ODMDS result in unacceptable adverse impacts, further studies may be required to determine the persistence of these impacts, the extent of the impacts within the marine system, and/or possible means of mitigation. In addition, the management plan presented may require revision based on the outcome of any monitoring program.

### 3.6 Reporting and Data Formatting.

3.6.1 Project Initiation and Violation Reporting. The USACE or other site user should notify EPA 15 days prior to the beginning of a dredging cycle or project disposal. The user is also required to notify the USACE and the EPA within 24 hours if a violation of the permit and/or contract conditions related to MPRSA Section 103 or SMMP requirements occur during disposal operations.

3.6.2 Disposal Monitoring Data. Due to concerns regarding potential significant impacts to critical nearshore resources should short-dumping or leakage occur, disposal monitoring data shall be provided to EPA Region 4 electronically on a daily basis. Data shall be provided per the EPA Region 4 XML format and delivered as an attachment to an email to [DisposalData.R4@epa.gov](mailto:DisposalData.R4@epa.gov). The XML format is available from EPA Region 4.



**Table 5.** Miami ODMDS Monitoring Strategies and Thresholds for Action

Goal	Technique	Sponsor	Rationale	Frequency	Threshold for Action	Management Options	
						Threshold Not Exceeded	Threshold Exceeded
Site Capacity	Modeling with field verification/calibration	USACE	Estimate aerial extent of benthic impact	Prior to New Work Project	New Work Volumes exceed estimated capacity	Continue to use site without further restrictions	-Enlarge site or designate additional site for new work (pursuant to Section 102 or 103 of the MPRSA) -Restrict disposal volumes -Modify disposal method/placement
	Sediment Profile Imaging	USACE/ EPA	Confirm aerial extent of disposal mound (apron) and benthic impact	Following New Work Project	Disposal mound footprint occurs outside ODMDS boundaries (5cm)		-Restrict disposal volumes -Modify disposal method/placement -Institute Environmental Effects Monitoring
Monitor Bathymetric Trends	Bathymetry	Site User	Determine the extent of the disposal mound and major bathymetric changes	Pre and post disposal for significant projects (>100,000cy)	Disposal mound occurs outside ODMDS boundaries	Continue Monitoring	-Modify disposal method/placement -Restrict Disposal Volumes
Trend Assessment Survey	Water and Sediment Quality, Benthic Community Analysis (40CFR228.13)	U.S. EPA	Periodically evaluate the impact of disposal on the marine environment (40CFR 228.9)	Approximately every 10 years as resources allow.	-Absence from the site of pollution sensitive biota -Progressive non-seasonal changes in water or sediment quality	Continue Monitoring	-Conduct Environmental Effects Monitoring or Advanced Environmental Effects Monitoring -Review dredged material evaluation procedures -Consider isolating dredged material (capping)

**Table 5 (Continued).** Miami ODMDS Monitoring Strategies and Thresholds for Action

Goal	Technique	Sponsor	Rationale	Frequency	Threshold for Action	Management Options	
						Threshold Not Exceeded	Threshold Exceeded
Environmental Effects Monitoring	Chemical Monitoring	EPA/USACE	Determine if chemical contaminants are significantly elevated <sup>1</sup> within and outside of site boundaries	Implement if disposal footprint extends beyond the site boundaries or if Trend Assessment results warrant.	Contaminants are found to be elevated <sup>1</sup>	Discontinue monitoring.	- Institute Advanced Environmental Effects Monitoring - Implement case specific management options (ie. Remediation, limits on quantities or types of material).
	Benthic Monitoring & Sediment Profile Imaging	EPA/USACE	Determine whether there are adverse changes in the benthic populations outside of the site and evaluate recovery rates		Adverse changes observed outside of the site that may endanger the marine environment		
Advanced Environmental Effects Monitoring	Tissue Chemical Analysis	EPA/USACE	Determine if the site is a source of adverse bioaccumulation which may endanger the marine environment	Implement if Environmental Effects Monitoring warrants.	Benthic body burdens and risk assessment models indicate potential for food chain impacts.	Discontinue monitoring	-Discontinue site use - Implement case specific management options (ie. Remediation, limits on quantities or types of material).
	Benthic Monitoring		Determine if the site is a source of adverse sub-lethal <sup>2</sup> changes in benthic organisms which may endanger the marine environment		Sub-lethal effects are unacceptable.		
Compliance	Disposal Site Use Records in EPA Region 4's XML format	Site User	-Insure management requirements are being met -To assist in site monitoring	Daily during the project	Disposal records required by SMMP are not submitted or are incomplete	Continue Monitoring	-Restrict site use until requirements are met

<sup>1</sup> Significantly elevated: Concentrations above the range of contaminant levels in dredged sediments that the Regional Administrator and the District Engineer found to be suitable for disposal at the ODMDS

<sup>2</sup> Examples of sub-lethal effects include without limitation the development of lesions, tumors, development abnormality, and/or decreased fecundity.

3.6.3 Post Disposal Summary Reports. A Post Disposal Summary Report shall be provided to EPA within 90 days after project completion. These reports should include: dredging project title; permit number and expiration date (if applicable); contract number; name of contractor(s) conducting the work, name and type of vessel(s) disposing material in the ODMDS; disposal timeframes for each vessel; volume disposed at the ODMDS (as paid *in situ* volume, total paid and un paid *in situ* volume, and gross volume reported by dredging contractor), number of loads to ODMDS, type of material disposed at the ODMDS; identification by load number of any misplaced material; dates of pre and post disposal bathymetric surveys of the ODMDS and a narrative discussing any violation(s) of the 103 concurrency and/or permit (if applicable). The narrative should include a description of the violation, indicate the time it occurred and when it was reported to the EPA and USACE, discuss the circumstances surrounding the violation, and identify specific measures taken to prevent reoccurrence. The Post Disposal Summary Report should be accompanied by the bathymetry survey results (plot and X,Y,Z ASCII data file), a summary scatter plot of all disposal start locations, and a summary table of the trip information required by Section 3.2 with the exception of the disposal completion data. If all data is provided in the required XML format, scatter plots and summary tables will not be necessary.

3.6.4 Environmental Monitoring. Material tracking, disposal effects monitoring and any other data collected shall be coordinated with and provided to SMMP team members and federal and state agencies as appropriate. Data will be provided to other interested parties requesting such data to the extent possible. Data will be provided for all surveys in a report generated by the action agency. The report should indicate how the survey relates to the SMMP and previous surveys at the Miami ODMDS and should provide data interpretations, conclusions, and recommendations, and should project the next phase of the SMMP. Monitoring results will be summarized in subsequent modifications to the SMMP.

#### 4.0 MODIFICATION OF THE MIAMI ODMDS SMMP

Should the results of the monitoring surveys or reports from other sources indicate that continued use of the ODMDS would lead to unacceptable effects, the ODMDS SMMP will be modified to mitigate the adverse impacts. The SMMP will be reviewed and revised at a minimum of every ten years. The SMMP will be reviewed and updated as necessary if site use changes significantly. For example, the SMMP will be reviewed if the quantity or type of dredged material placed at the site changes significantly or if conditions at the site indicate a need for revision.

## 5.0 REFERENCES

Fredette, Thomas J., Nelson, David A., Clausner, James E., and Anders, Fred J. 1990. *Guidelines for Physical and Biological Monitoring of Aquatic Dredged Material Disposal Sites*, Technical Report D-90-12, US Army Engineer Waterways Experiment Station, Vicksburg, MS.

National Oceanic and Atmospheric Administration (NOAA). 2006. *Review of the Real-Time Current Monitoring Requirement for the Miami Ocean Dredged Material Disposal Site (1995-2000)*. National Oceanic and Atmospheric Administration Atlantic Oceanographic and Meteorological Laboratory, Miami, Florida and the U.S. Environmental Protection Agency Region 4/Water Management Division, Atlanta, Georgia, July 2006.

Pequegnat, Willis E., Gallaway, Benny J., and Wright, Thomas D., 1990. *Revised Procedural Guide for Designation Surveys of Ocean Dredged Material Disposal Sites*, Technical Report D-90-8, US Army Engineer Waterways Experiment Station, Vicksburg, MS.

U.S. Army Corps of Engineers. 2004. *Navigation Study for Miami Harbor Final General Reevaluation Report and Environmental Impact Statement*. Miami-Dade County, Florida – 010140. Jacksonville District. February 2004.

U.S. Environmental Protection Agency (EPA). 1995. *Final Environmental Impact Statement (EIS) for Designation of an Ocean Dredged Material Disposal Site Located Offshore Miami, Florida*, August 1995.

U.S. Environmental Protection Agency (EPA). 2001. *Sediment Survey: Miami Ocean Dredged Material Disposal Site*. Water Management Division & Science and Ecosystem Support Division. July, 2001.

U.S. Environmental Protection Agency (EPA). 2004. Letter to USACE – Headquarters re: FEIS for the Miami Harbor Navigation Upgrades, Miami-Dade County, FL, (dtd. February, 2004).

U.S. Environmental Protection Agency and U.S. Army Corps of Engineers, 1991. *Evaluation of Dredged Material Proposed for Ocean Disposal (Testing Manual)*, February 1991. Prepared by Environmental Protection Agency Office of Marine and Estuarine Protection and Department of Army United States Army Corps of Engineers under EPA Contract No. 68-C8-0105.

U.S. Environmental Protection Agency and U.S. Army Corps of Engineers, 1996. *Guidance Document for Development of Site Management Plans for Ocean Dredged Material Disposal Sites*, February 1996. Prepared by Environmental Protection Agency Office of Water and Department of Army United States Army Corps of Engineers.

U.S. Environmental Protection Agency Region 4 and U.S. Army Corps of Engineers South Atlantic Division, 1993. *Regional Implementation Manual Requirements and Procedures for Evaluation of the Ocean Disposal of Dredged Material in Southeastern Atlantic and Gulf Coastal Waters*, May 1993.

U.S. Environmental Protection Agency Region 4 and U.S. Army Corps of Engineers South Atlantic Division, 2007. *Memorandum of Understanding Between U.S. EPA Region 4 and the USACE South Atlantic Division on Ocean Dredged Material Disposal*, March 2007.

## APPENDIX A

### STATE WATER QUALITY MODEL STANDARD INPUT PARAMETERS

This page intentionally left blank.

Water Column Evaluations  
 Numerical Model (STFATE) Input Parameters  
**Miami ODMDS**

**SITE DESCRIPTION**

Parameter	Value	Units
Number of Grid Points (left to right)	80	
Number of Grid Points (top to bottom)	80	
Spacing Between Grid Points (left to right)	250	ft
Spacing Between Grid Points (top to bottom)	250	ft
Constant Water Depth	570	ft
Roughness Height at Bottom of Disposal Site	.005 <sup>1</sup>	ft
Slope of Bottom in X-Direction	-0.4	deg.
Slope of Bottom in Z-Direction	3.3	deg.
Number of Points in Ambient Density Profile <sup>2</sup> Point	5	
Ambient Density at Depth = 0 ft	1.0224	g/cc
Ambient Density at Depth = 164 ft	1.0232	g/cc
Ambient Density at Depth = 328 ft	1.0256	g/cc
Ambient Density at Depth = 492 ft	1.0268	g/cc
Ambient Density at Depth = 570 ft	1.0274	g/cc

**AMBIENT VELOCITY DATA<sup>3</sup>**

Parameter	Value	Units
Profile	2-Point at constant depth	
X-Direction Velocity at Depth = 65 feet	-2.5	ft/sec
Z-Direction Velocity at Depth = 65 feet	+0.5	ft/sec
X-Direction Velocity at Depth = 164 feet	-2.3	ft/sec
Z-Direction Velocity at Depth = 164 feet	+0.5	ft/sec

**DISPOSAL OPERATION DATA**

Parameter	Value	Units
Location of Disposal Point from Top of Grid	15,740	ft
Location of Disposal Point from Left Edge of Grid	10,000	ft
Dumping Over Depression	0	



**INPUT, EXECUTION AND OUTPUT**

Parameter	Value	Units
Location of the Upper Left Corner of the Disposal Site - Distance from Top Edge	11,000	ft
Location of the Upper Left Corner of the Disposal Site - Distance from Left Edge	7,000	ft
Location of the Lower Right Corner of the Disposal Site - Distance from Top Edge	17,000	ft
Location of the Lower Right Corner of the Disposal Site - Distance from Left Edge	13,000	ft
Duration of Simulation	14,400	sec
Long Term Time Step	600	sec

**COEFFICIENTS**

Parameter	Keyword	Value
Settling Coefficient	BETA	0.000 <sup>1</sup>
Apparent Mass Coefficient	CM	1.000 <sup>1</sup>
Drag Coefficient	CD	0.500 <sup>1</sup>
Form Drag for Collapsing Cloud	CDRAG	1.000 <sup>1</sup>
Skin Friction for Collapsing Cloud	CFRIC	0.010 <sup>1</sup>
Drag for an Ellipsoidal Wedge	CD3	0.100 <sup>1</sup>
Drag for a Plate	CD4	1.000 <sup>1</sup>
Friction Between Cloud and Bottom	FRICTN	0.010 <sup>1</sup>
4/3 Law Horizontal Diffusion Dissipation Factor	ALAMDA	0.001 <sup>1</sup>
Unstratified Water Vertical Diffusion Coefficient	AKYO	Pritchard Expression
Cloud/Ambient Density Gradient Ratio	GAMA	0.250 <sup>1</sup>
Turbulent Thermal Entrainment	ALPHAO	0.39 <sup>4</sup>
Entrainment in Collapse	ALPHAC	0.100 <sup>1</sup>
Stripping Factor	CSTRIP	0.003 <sup>1</sup>

<sup>1</sup> Model default value

<sup>2</sup> Profiles from EPA 2007 Status and Trends Survey

<sup>3</sup> Velocity data represents median conditions. Determined from EPA/NOAA analysis of ADCP data collected at and near the Miami ODMDS 1995-2000.

<sup>4</sup> Calculated from NOAA field work at Miami (1991)

Dilution Rates for Generic Material (4,000 cy):

Minimum dilution outside disposal site: 64,500 to 1; minimum dilution after 4 hours: 3,875 to 1

<b>Jacksonville ODMDS Background Water Concentration.</b>	
<b>Chemicals of Concern</b>	<b>Background Concentration Levels (µg/l)</b>
Arsenic	1.34 <sup>1</sup>
Cadmium	0.014 <sup>1</sup>
Chromium (VI)	0.210 <sup>1</sup>
Copper	0.182 <sup>1</sup>
Lead	0.061 <sup>1</sup>
Mercury	0.002 <sup>1</sup>
Nickel	0.264 <sup>1</sup>
Selenium	0.2 <sup>1,3</sup>
Silver	0.003 <sup>1,3</sup>
Zinc	0.770 <sup>1</sup>
Ammonia	2.5 <sup>2,3</sup>
Cyanide	2.0 <sup>2,3</sup>
Tributyltin (TBT)	0.025 <sup>1,3</sup>
Aldrin	0.005 <sup>2,3</sup>
Chlordane	0.005 <sup>2,3</sup>
DDT	0.005 <sup>2,3</sup>
Dieldrin	0.005 <sup>2,3</sup>
alpha - Endosulfan	0.005 <sup>2,3</sup>
beta - Endosulfan	0.005 <sup>2,3</sup>
Endrin	0.005 <sup>2,3</sup>
gamma-BHC (Lindane)	0.005 <sup>2,3</sup>
Heptachlor	0.005 <sup>2,3</sup>
Heptachlor Epoxide	0.005 <sup>2,3</sup>
Toxaphene	0.245 <sup>2,3</sup>
Parathion	No Data
Pentachlorophenol	5.0 <sup>1,3</sup>

<sup>1</sup> 2007 EPA Status and Trends Survey at the Miami ODMDS

<sup>2</sup> Reference site water collected as part of the 2002 Miami Harbor Dredged Material 103 Evaluation.

<sup>3</sup> Analyte not detected. Value based on one half the reporting limit.

# Miami ODMDS STFATE Input Parameters

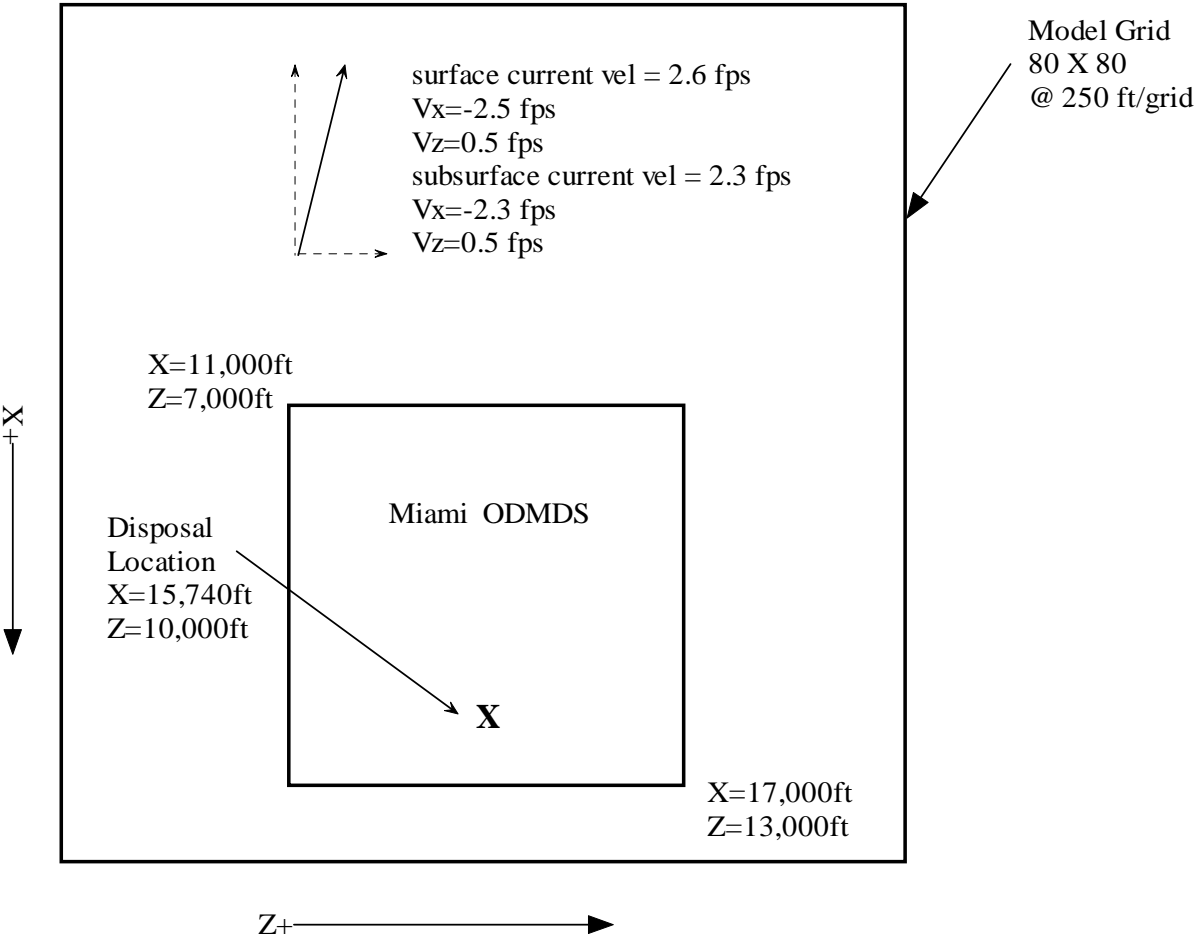

# APPENDIX B

## TEMPLATE GENERIC SPECIAL CONDITIONS FOR MPRSA SECTION 103 PERMITS

This page intentionally left blank

**GENERIC SPECIAL CONDITIONS  
FOR MPRSA SECTION 103 PERMITS**

**I. DISPOSAL OPERATIONS**

A. For this permit, the term disposal operations shall mean: navigation of any vessel used in disposal of operations, transportation of dredged material from the dredging site to the Miami ODMDS, proper disposal of dredged material at the disposal area within the Miami ODMDS, and transportation of the hopper dredge or disposal barge or scow back to the dredging site.

B. The Miami ODMDS is defined as the rectangle with center coordinates of 25° 45.00'N latitude and 80°03.37'W longitude (NAD 27) or state plane coordinates 516,078 N and 966,926 E (NAD83). The site coordinates are as follows:

	Geographic (NAD27)		Geographic (NAD83)		State Plane (FL East 0901 Ft NAD83)	
Center	25°45.00'N	80°03.37'W	25°45.02'N	Center	25°45.00'N	80°03.37'W
NW Corner	25°45.50'N	80°03.90'W	25°45.52'N	NW Corner	25°45.50'N	80°03.90'W
NE Corner	25°45.50'N	80°02.83'W	25°45.52'N	NE Corner	25°45.50'N	80°02.83'W
SW Corner	25°44.50'N	80°03.90'W	25°44.52'N	SW Corner	25°44.50'N	80°03.90'W
SE Corner	25°44.50'N	80°02.83'W	25°44.52'N	SE Corner	25°44.50'N	80°02.83'W

C. No more than [NUMBER] cubic yards of dredged material excavated at the location defined in [REFERENCE LOCATION IN PERMIT] are authorized for disposal at the Miami ODMDS.

D. The permittee shall use an electronic positioning system to navigate to and from the Miami ODMDS. For this section of the permit, the electronic positioning system is defined as: a differential global positioning system or a microwave line of site system. Use of LORAN-C alone is not an acceptable electronic positioning system for disposal operations at the Miami ODMDS. If the electronic positioning system fails or navigation problems are detected, all disposal operations shall cease until the failure or navigation problems are corrected.

E. The permittee shall certify the accuracy of the electronic positioning system proposed for use during disposal operations at the Miami ODMDS. The certification shall be accomplished by direct comparison of the electronic positioning system's accuracy with a known fixed point.

F. The permittee shall not allow any water or dredged material placed in a hopper dredge or disposal barge or scow to flow over the sides or leak from such vessels during transportation to the Miami ODMDS.

G. A disposal operations inspector and/or captain of any tug boat, hopper dredge or other vessel used to transport dredged material to the Miami ODMDS shall insure compliance with disposal operation conditions defined in this permit.

1. If the disposal operations inspector or the captain detects a violation, he shall report the violation to the permittee immediately.

2. The permittee shall contact the U.S. Army Corps of Engineers, Jacksonville District's Regulatory Branch [TELEPHONE NUMBER] and EPA Region 4 at (404) 562-9391 to report the violation within twenty-four (24) hours after the violation occurs. A complete written explanation of any permit violation shall be included in the disposal summary report.

H. When dredged material is disposed, no portion of the hopper dredge or disposal barge or scow shall be outside of the boundaries of the Miami ODMDS as defined in Special Condition B. Additionally, disposal shall be initiated within the disposal release zone defined by the following coordinates:

	Geographic (NAD83)		State Plane (FL East 0901 Ft NAD83)	
	Center	25°44.81'N	81°03.36'W	514,789 N
NW Corner	25°44.89'N	81°03.71'W	515,260 N	964,970 E
NE Corner	25°44.89'N	81°03.00'W	515,288 N	968,866 E
SW Corner	25°44.73'N	81°03.71'W	514,291 N	964,977 E
SE Corner	25°44.73'N	81°03.00'W	514,319 N	968,873 E

I. During transit to and from the Miami ODMDS, the hopper dredge or disposal barge or scow shall remain within the navigation channel until east of the buoy G'1". The hopper dredge or disposal barge or scow shall not transit the Particularly Sensitive Sea Area during transit to or from the ODMDS.

J. The permittee shall use an electronic tracking system (ETS) that will continuously track the horizontal location and draft condition of the disposal vessel (hopper dredge or disposal barge or scow) to and from the Miami ODMDS. Data shall be collected at least every 500 feet during travel to and from the ODMDS and every minute or every 200 feet of travel, whichever is smaller, while approaching within 1,000 feet and within the ODMDS. The permittee shall use Florida State Plane or latitude and longitude coordinates (North American Datum 1983). State Plane coordinates shall be reported to the nearest foot and latitude and longitude coordinates shall be reported as decimal degrees out to 6 decimals. Westerly longitudes are to be reported as negative. Draft readings shall be recorded in feet out to 2 decimals.

K. The permittee shall record electronically for each load the following information:

- a. Load Number
- b. Disposal Vessel or Scow Name
- c. Tow Vessel Name (if scow used)
- d. Captain of Disposal or Tow Vessel
- e. Estimated volume of Load
- f. Description of Material Disposed
- g. Source of Dredged Material
- h. Date, Time and Location at Start at Initiation and Completion of Disposal Event
- i. The ETS data required by Special Condition I.

L. The permittee shall conduct a bathymetric survey of the Miami ODMDS within 3 months

prior to project disposal and within 60 days following project completion.

1. The number and length of the survey transects shall be sufficient to encompass the Miami ODMDS and a 500 foot wide area around the site. The transects shall be spaced at 500-foot intervals or less.

2. Vertical accuracy of the survey shall be  $\pm 0.5$  feet. Horizontal location of the survey lines and depth sounding points will be determined by an automated positioning system utilizing either microwave line of site system or differential global positioning system. The vertical datum shall be mean lower low water (m.l.l.w) and the horizontal datum shall use Florida State Plane or latitude and longitude coordinates (North American Datum 1983). State Plane coordinates shall be reported to the nearest 0.10 foot and latitude and longitude coordinates shall be reported as decimal degrees to 6 decimal points.

L. Enclosed is the Regional Biological Opinion (RBO) dated [INSERT DATE], for swimming sea turtles, whales, and sturgeon. The RBO contains mandatory terms and conditions to implement the reasonable and prudent measures that are associated with "incidental take" that is also specified in the RBO. Your authorization under the Corps permit is conditional upon your compliance with all of the mandatory terms and conditions associated with the incidental take of the attached RBO, which terms and conditions are incorporated by reference in the permit. Failure to comply with the terms and conditions associated with the incidental take of the RBO, where a take of the listed species occurs, would constitute an unauthorized take, and it would also constitute non-compliance with your Corps permit. However, depending on the affected species NMFS is the appropriate authority to determine compliance with the terms and conditions of its RBO and with the Endangered Species Act (ESA). For further clarification on this point, you should contact the appropriate agency. Should they determine that the conditions of the RBO have been violated; normally they will enforce the violation of the ESA, or refer the matter to the Department of Justice.

## II. REPORTING REQUIREMENTS

A. All reports, documentation and correspondence required by the conditions of this permit shall be submitted to the following addresses: U.S. Army Corps of Engineers (Corps), Regulatory Division, Enforcement Section, P.O. Box 4970, Jacksonville, Florida 32232-0019 and U. S. Environmental Protection Agency (EPA) Region 4's Wetlands, Coastal and Watersheds Branch, 61 Forsyth Street, Atlanta, GA 30303. The Permittee shall reference this permit number, [INSERT PERMIT NUMBER], on all submittals.

B. At least 15 days before initiating any dredging operations authorized by this permit, the Permittee shall provide to the Corps and EPA a written notification of the date of commencement of work authorized by this permit.

C. Electronic data required by Special Conditions I.J and I.K shall be provided to EPA Region 4 on a weekly basis. Data shall be submitted as an eXtensible Markup Language (XML) document via Internet e-mail to [DisposalData.R4@epa.gov](mailto:DisposalData.R4@epa.gov). XML data file format specifications are



available from EPA Region 4.

D. The permittee shall send one (1) copy of the disposal summary report to the Jacksonville District's Regulatory Branch and one (1) copy of the disposal summary report to EPA Region 4 documenting compliance with all general and special conditions defined in this permit. The disposal summary report shall be sent within 90 days after completion of the disposal operations authorized by this permit. The disposal summary report shall include the following information:

1. The report shall indicate whether all general and special permit conditions were met. Any violations of the permit shall be explained in detail.

2. The disposal summary report shall include the following information: dredging project title; dates of disposal; permit number and expiration date; name of contractor(s) conducting the work, name and type of vessel(s) disposing material in the ODMDS; disposal timeframes for each vessel; volume disposed at the ODMDS (as paid *in situ* volume, total paid and un paid *in situ* volume, and gross volume reported by dredging contractor), number of loads to ODMDS, type of material disposed at the ODMDS; identification of any misplaced material (outside disposal zone or the ODMDS boundaries); dates of pre and post disposal bathymetric surveys of the ODMDS and a narrative discussing any violation(s) of the 103 permit. The disposal summary report should be accompanied by the bathymetry survey results (plot and X,Y,Z ASCII data file).

## APPENDIX C

# TYPICAL CONTRACT LANGUAGE FOR IMPEMENTING THE MIAMI ODMDS SMMP REQUIREMENTS

This page intentionally left blank

TYPICAL CONTRACT LANGUAGE FOR IMPEMENTING SMMP  
REQUIREMENTS

3.3 DISPOSAL OF DREDGED MATERIAL

3.3.1 General

All material dredged shall be transported to and deposited in the disposal area(s) designated on the drawings. The approximate maximum and average distance to which the material will have to be transported are as follows:

Disposal Area	Maximum Distance Statute Miles	Average Distance Statute Miles
---------------	-----------------------------------	-----------------------------------

Miami ODMDS

[INSERT DISPOSAL AREA 2]	[XX miles]	[XX miles]
-----------------------------	------------	------------

[IF MATERIAL FROM DIFFERENT PROJECT AREAS GO TO DIFFERENT  
DISOSAL AREAS, IT COULD BE SPECIFIED HERE]

3.3.2 Ocean Disposal Notification

- a. The contractor shall notify EPA Region 4 's Wetlands, Coastal and NonPoint Source Branch (61 Forsyth Street, Atlanta, GA 30303) at least 15 calendar days and the local Coast Guard Captain of the Port at least 5 calendar days prior to the first ocean disposal. The notification will be by certified mail with a copy to the Contracting Officer. The following information shall be included in the notification:
  - (1) Project designation; Corps of Engineers' Contracting Officer's name and contract number; and, the Contractor's name, address, and telephone number.
  - (2) Port of departure.
  - (3) Location of ocean disposal area (and disposal zone if required).
  - (4) Schedule for ocean disposal, giving date and time proposed for first ocean disposal.

3.3.3 Ocean Dredged Material Disposal Sites (ODMDS)

The material excavated shall be transported to and deposited in the Miami ODMDS shown on the drawings. When dredged material is disposed, no portion of the hopper dredge or disposal barge or scow shall be outside of the boundaries of the Miami ODMDS as shown on the drawings. Additionally, disposal shall be initiated within the disposal release zone defined by the following coordinates:

	Geographic (NAD83)		State Plane (FL East 0901 Ft NAD83)	
Center	25°44.81'N	81°03.36'W	514,789 N	966,894 E
NW Corner	25°44.89'N	81°03.71'W	515,260 N	964,970 E
NE Corner	25°44.89'N	81°03.00'W	515,288 N	968,866 E
SW Corner	25°44.73'N	81°03.71'W	514,291 N	964,977 E
SE Corner	25°44.73'N	81°03.00'W	514,319 N	968,873 E

During transit to and from the Miami ODMDS, the hopper dredge or disposal barge or scow shall remain within the navigation channel until east of the buoy G"1". The hopper dredge or disposal barge or scow shall not transit the Particularly Sensitive Sea Area during transit to or from the ODMDS.

### 3.3.4 Logs

The Contractor shall keep a log for each load placed in the Miami ODMDS. The log entry for each load shall include:

- a. Load Number
- b. Disposal Vessel or Scow Name
- c. Tow Vessel Name (if scow used)
- d. Captain of Disposal or Tow Vessel
- e. Estimated volume of Load
- f. Description of Material Disposed
- g. Source of Dredged Material
- h. Date, Time and Location (coordinates) at Start of Initiation and Completion of Disposal Event

At the completion of dredging and at any time upon request, the log(s) shall be submitted in paper and electronic formats to the Contracting Officer for forwarding to the appropriate agencies.

### 3.3.5 Overflow, Spills and Leaks

Water and dredged materials shall not be permitted to overflow or spill out of barges, hopper dredges, or dump scows during transport to the disposal site(s). Failure to repair leaks or change the method of operation which is resulting in overflow of spillage will result in suspension of dredging operations and require prompt repair or change of operation to prevent overflow or spillage as a prerequisite to the resumption of dredging.

### 3.3.6 Electronic Tracking System (ETS) for Ocean Disposal Vessels

The Contractor shall furnish an ETS for surveillance of the movement and disposition of dredged material during dredging and ocean disposal. This ETS shall be established, operated and maintained by the Contractor to continuously track in real-time the

horizontal location and draft condition of the disposal vessel (hopper dredge or disposal barge or scow) for the entire dredging cycle, including dredging area and disposal area. The ETS shall be capable of displaying and recording in real-time the disposal vessel's draft and location.

-----  
[USE LANGUAGE BELOW FOR NON SI PROJECTS]

#### 3.3.6.1 ETS Standards

The Contractor shall provide automated (computer) system and components to perform in accordance with COE EM 1110-1-2909. A copy of the EM can be downloaded from the following web site: <http://www.usace.army.mil/inet/usace-docs/eng-manuals/em.htm>. Horizontal location shall have an accuracy equal to or better than a standard DGPS system, equal to or better than plus/minus 10 feet (horizontal repeatability). Vertical (draft) data shall have an accuracy of plus/minus 0.5 foot. Horizontal location and vertical data shall be collected in sets and each data set shall be referenced in real-time to date and local time (to nearest minute), and shall be referenced to the same state plane coordinate system used for the survey(s) shown in the contract plans. The ETS shall be calibrated, as required, in the presence of the Contracting Officer at the work location before disposal operations have started, and at 30-day intervals while work is in progress. The Contracting Officer shall have access to the ETS in order to observe its operation. Disposal operations will not commence until the ETS to be used by the Contractor is certified by the Contracting Officer to be operational and within acceptable accuracy. It is the Contractor's responsibility to select a system that will operate properly at the work location. The complete system shall be subject to the Contracting Officer's approval.

#### 3.3.6.2 ETS Data Requirements and Submissions

- a. The ETS for each disposal vessel shall be in operation for all dredging and disposal activities and shall record the full round trip for each loading and disposal cycle. (NOTE: A dredging and disposal cycle constitutes the time from commencement of dredging to complete discharge of the material.) The Contracting Officer shall be notified immediately in the event of ETS failure and all dredging operations for the vessel shall cease until the ETS is fully operational. Any delays resulting from ETS failure shall be at the Contractor's expense.
- b. Data shall be collected, during the dredging and disposal cycle, every 500 feet (at least) during travel to the disposal area, and every minute or every 200 feet, whichever is smaller, while approaching within 1,000 feet and within the disposal area.
- b. Plot Reporting (2 types):
  - ( 1 ) Tracking Plot - For each disposal event, data collected while the disposal vessel is in the vicinity of the disposal area shall be plotted in chart form, in

200-foot intervals, to show the track and draft of the disposal vessel approaching and traversing the disposal area. The plot shall identify the exact position at which the dump commenced. A sample Track and Draft Plot Diagram is on the web site indicated in paragraph CONSTRUCTION FORMS AND DETAILS below.

- (2) Scatter Plot - Following completion of all disposal events, a single and separate plot will be prepared to show the exact disposal locations of all dumps. Every plotted location shall coincide with the beginning of the respective dump. Each dump shall be labeled with the corresponding Trip Number and shall be at a small but readable scale. A sample Scatter Plot Diagram is on the web site indicated in paragraph CONSTRUCTION FORMS AND DETAILS below.
  - (3) Summary Table – A spreadsheet which contains all of the information in the log(s) [Section 3.3.4] above shall be prepared and shall correspond to the exact dump locations represented on the Scatter Plot. A sample Summary Table spreadsheet is on the web site indicated in paragraph CONSTRUCTION FORMS AND DETAILS below.
- c. ETS data and log data required by Section 3.3.4 shall be provided to EPA Region 4 on a weekly or more frequent basis. Data shall be submitted to EPA Region 4 as an eXtensible Markup Language (XML) document via Internet e-mail to [DisposalData.R4@epa.gov](mailto:DisposalData.R4@epa.gov). XML data file format specifications are available from EPA Region 4. All digital ETS data shall be furnished to the Contracting Officer within 24 hours of collection. The digital plot files should be in an easily readable format such as Adobe Acrobat PDF file, Microstation DGN file, JPEG, BMP, TIFF, or similar. The hard copy of the ETS data and tracking plots shall be both maintained onboard the vessel and submitted to the Contracting Officer on a weekly basis.

-----  
[USE LANGUAGE BELOW FOR SI PROJECTS]

### 3.3.6.3 Silent Inspector – Special Standard of Responsibility

#### 3.3.6.3.1 General

The Silent Inspector (SI) is an automated dredge contract monitoring system comprised of both hardware and software developed by the Army Corps of Engineers (the Corps). The Corps developed the SI as a low cost, repeatable, impartial system for automated dredge monitoring. The SI systems integrate various automated systems to record digital dredging and disposal activities in real-time on a 24 hour/7 days a week basis. Information is recorded to the on-board computer where it is available to the Corps Quality Assurance Representative (QAR) for examination and for periodic download and transmittal via an automated email service for inclusion in the SI database. The dredging contractor supplies and owns the on-board system and all associated sensors. Additional information about SI and SI specifications can be found at <http://si.usace.army.mil>.

#### 3.3.6.3.2 Requirement

As authorized by FAR 9.104-2, Contracting Officers may establish special standards of responsibility when necessary. The Contracting Officer has determined that use of the SI is necessary for work performed by hopper dredge and disposal scows. Therefore, in order to be considered responsible for performing this contract, the Offeror must establish prior to contract award that any hopper dredge or disposal scows to be used in performance of this contract has been outfitted with the SI system and the system has been certified by the Engineer Research and Development Center (ERDC) within the last year. Disposal scows shall utilize the monitoring or TDS profile. Questions regarding certification should be addressed to the SI support team at 601-634-2923.

#### 3.3.6.3.3 Data Submissions

Scow data shall be transferred by the contractor automatically to the SI database on intervals not to exceed 24 hours. Hopper dredged data shall be transferred in accordance with the Hopper Dredge Specifications found at <http://si.usace.army.mil>.

---

#### 3.3.6.4 Misplaced Materials

Materials deposited outside of the disposal zone specified in 3.3.3 will be classified as misplaced material and will result in a suspension of dredging operations. Redredging of such materials will be required as a prerequisite to the resumption of dredging unless the Contracting Officer, at his discretion, determines that redredging of such material is not practical. If redredging of such material is not required then the quantity of such misplaced material shall be deducted from the Contractor's pay quantity. If the quantity for each misplaced load to be deducted cannot initially be agreed to by both the Contractor and Contracting Officer, then an average hopper/scow load quantity for the entire contract will be used in the determination. Misplaced loads may also be subject to penalty under the Marine, Protection, Research and Sanctuaries Act. Materials deposited above the maximum indicated elevation or outside of the disposal area template shown will require the redredging or removal of such materials at the Contractor's expense. In addition, the Contractor must notify the Contracting Officer and the Environmental Protection Agency Region 4 's Wetlands, Coastal and NonPoint Source Branch (61 Forsyth Street, Atlanta, GA 30303) within 24 hours of a misplaced dump or any other violation of the Site Management and Monitoring Plan for the Miami ODMDS. Corrective actions must be implemented by the next dump and the Contracting Officer must be informed of actions taken.